

AKP 161 - AKZ 162 - AKZ 517
AKP 801 - AKP 803

Users Guide & Installation Handbook

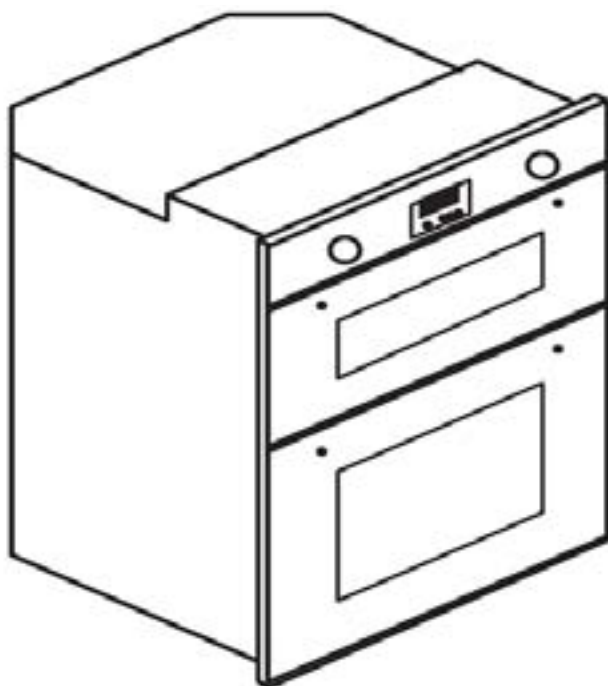

User and maintenance manual

The Whirlpool logo, featuring the word 'Whirlpool' in a stylized, bold font with a swirl graphic above the 'i'.

SENSING THE DIFFERENCE

CONTENTS & INTRODUCTION

CONTENTS

- SAFETY
- USING THE PRODUCT
- CLEANING
- INSTALLATION INSTRUCTIONS
- TECHNICAL DATA
- CUSTOMER CARE

INTRODUCTION

Thank you for buying this British-built appliance from us.

This guide book is designed to help you through each step of owning your new cooker, from installation to use. Please read it carefully before you start using your product, as we have endeavored to answer as many questions as possible, and provide you with as much support as we can.

SAFETY

BEFORE USING THE PRODUCT

Make sure that you have removed all packaging and wrapping. Some of the items inside this appliance may have additional wrapping.

Caution: Use gloves for unpacking the appliance.

Caution: This appliance is for cooking purposes only. It must not be used for other purposes, for example room heating.

GENERAL

Warning! - Accessible parts may become hot during use. To avoid burns, young children should be kept away from the appliance.

Children should be supervised to ensure that they do not play with the appliance. This appliance is not intended for use by persons (including children with reduced physical, sensory or mental capabilities, or lack of experience and knowledge) unless they have been given supervision or instruction concerning use of the appliance by a person responsible for their safety.

Warning! - Servicing should be carried out only by authorised personnel.

- The appliance must never be disconnected from the mains supply during use, as this will seriously affect the safety and performance, particularly in relation to surface temperatures becoming hot. The cooling fan (if fitted) is designed to run on after the control knob has been switched off.

Do not spray aerosols in the vicinity of this appliance while it is in operation.

Do not store or use flammable liquids or items in the vicinity of this appliance.

Do not modify this appliance.

OVEN / GRILL

Do

- Always take care when removing food from the oven as the area around the cavity may be hot.

- Always use oven gloves when handling any utensils that have been in the oven as they will be hot.
- Always make sure that the oven shelves are resting in the correct position between two runners. Do not place the oven shelves on top of the highest runner, as this is not stable and can lead to spillage or injury.
- Always use the Minute Minder (if fitted) if you are leaving the oven unattended - this reduces the risk of food burning.

Do Not

- Never place items on the door while it is open.
- Never wrap foil around the oven shelves or allow foil to block the flue.
- Never drape tea towels near the oven while it is on; this will cause a fire hazard.
- Never pull heavy items, such as turkeys or large joints of meat, out from the oven on the shelf, as they may overbalance and fall.
- Never use this appliance to heat anything other than food items and do not use it for heating the room.

DECLARATION OF CONFORMITY

This oven, which intended to come in contact with foodstuffs, complies with European Regulation (CE) n.1935/2004 and has been designed, manufactured and sold in conformity with the safety requirements of the "Low Voltage" directive 2006/95/CE (which replaces 73/23/CEE and subsequent amendments), the protection requirements of "EMC" 2004/108/CE.

USING THE GRILL - ELECTRIC

Caution: Accessible parts may be hot when the grill is used - young children should be kept away.

If cleaning the grill pan when it is hot, use oven gloves to move it.

Food for grilling should be positioned centrally on the trivet.

Using the grill

Important: The grill door must be fully open when the grill is used.

Open the grill door. Turn the control knob to the required setting. For best cooking results, we recommend that you preheat the dual grill for 3 minutes and the single grill for 5 minutes.

For grilling small quantities of food, the centre (economy) grill can be used with the grill trivet inverted. For large quantities of food, the full grill can be used.

To switch off, turn the control knob to the off ● position.

Using aluminium foil

Using aluminium foil to cover the grill pan, or putting items wrapped in foil under the grill creates a fire hazard.

The cooling fan

When the grill is switched on, the cooling fan comes on to keep the fascia and control knobs cool during grilling. The fan may continue to operate for a period after the grill has been switched off.

During use the fan may cycle on and off, this is normal.

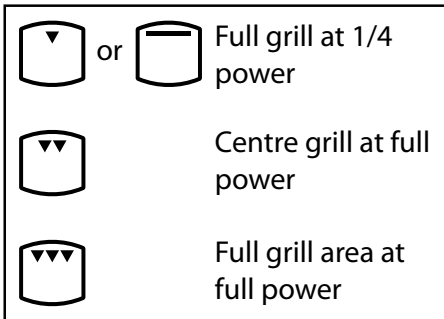

Push the grill pan towards the back of the shelf, to position it under the grill.

The speed of grilling can be controlled by adjusting the grill setting or by selecting a higher or lower shelf position. For toasting, and for grilling foods such as bacon, sausages or steaks, use a higher shelf position. For thicker foods such as chops or chicken joint pieces, use a middle to low shelf position.

The grill trivet, inside the grill pan, can be inverted to give a high or low position, or it may be removed.

USING THE TOP OVEN - ELECTRIC

When you are cooking keep children away from the vicinity of the oven.

Caution: The top element gets extremely hot when in use, so take extra care to avoid touching it.

The top oven is a conventional oven.

Note: The top oven is not controlled by the programmer (if fitted).

To turn on the top oven

Turn the temperature control knob until the required temperature is selected.

The red thermostat indicator will come on until the selected temperature is reached, and then go off; it will turn on and off periodically as the thermostat operates to maintain the selected temperature.

To switch off, return the top oven control knob to the off position.

Important: Never put items directly on the base of the oven, or cover the oven base with foil, as this may cause the element to overheat. Always position items on the shelf.

The cooling fan

When the top oven is switched on, you will hear the cooling fan come on - this keeps the fascia and control knobs of the appliance cool during cooking. The fan may continue to operate for a period after the oven control has been switched off.

Preheating

The oven must be preheated when cooking frozen or chilled foods, and we recommend preheating for yeast mixtures, batters, soufflés, and whisked sponges.

Preheat the oven until the indicator light switches off for the first time, this will take up to 15 minutes depending on the temperature selected.

If you are not preheating the oven, the cooking times in the following guide may need to be extended, as they are based on a preheated oven.

Shelf positions

There are 4 shelf positions which are counted from the bottom of the oven upwards, so shelf position 1 is the lowest.

When cooking frozen or chilled food, use the highest possible shelf position, while allowing some clearance between the food and the top element.

The oven shelf must be positioned with the up-stand at the rear of the oven and facing up. Position baking trays and roasting tins on the middle of the shelves, and leave one clear shelf position between shelves, to allow for circulation of heat.

When using the top oven

As part of the cooking process, hot air is expelled through a vent at the top of the oven(s). When opening the oven door, care should be taken to avoid any possible contact with potentially hot air, since this may cause discomfort to people with sensitive skin. We recommend that you hold the underneath of the oven door handle.

USING THE TOP OVEN - ELECTRIC

TOP OVEN BAKING GUIDE

Cooking times

These times are based on cooking in a preheated oven.

These cooking times are approximate, because the size and type of cooking dish will influence time as personal preferences.

Shelf positions

As a general guide, when cooking frozen or chilled food, use the highest possible shelf position, while allowing some clearance between the food and the top element. Follow the instructions given on packaging.

Cooking temperatures

The temperature settings and time given in the Baking Guides are based on dishes made with block margarine. If soft tub margarine is used, it may be necessary to reduce the temperature setting. If a recipe gives a different temperature setting to that shown in the guide, the recipe instruction should be followed.

Because the top oven is more compact, it may be necessary to reduce cooking temperatures specified in recipes by up to 20°C.

Use the baking guide as a reference for determining which temperatures to use.

Item	Temperature (°C)	Shelf Position	Approximate cooking time
Small cakes	180	1	15 - 20 mins
Victoria sandwich (2 x 180mm / 7")	160	1	20 - 25 mins
Swiss roll	200	1	8 - 12 mins
Semi rich fruit cake (180mm x 7")	140	1	2¼ - 2¾ hours
Scones	215	1	10 - 15 mins
Meringues	90 - 100	1	2 - 3 hours
Shortcrust pastry	200 - 210	1	Depends on size & type of cooking dish & also the filling
Puff / flaky pastry	200 - 210	1	
Choux pasrty	200 - 210	1	
Biscuits	160 - 200	2	10 - 20 mins
Sponge pudding	150	1	30 - 45 mins
Milk pudding	140	1	2 - 2½ hours

USING THE MAIN OVEN - ELECTRIC

Accessible parts may be hot when the oven is used. Young children should be kept away.

To switch on the oven

Turn the oven control knob(s) to the required setting.

The red thermostat indicator (if fitted) will come on until the selected temperature is reached and then go off; it will turn on and off periodically as the thermostat operates to maintain the selected temperature.

To switch off, return the control knob to the off ● position.

When using the oven

As part of the cooking process, hot air is expelled through a vent in the oven. When opening the oven door, care should be taken to avoid any possible contact with potentially hot air, since this may cause discomfort to people with sensitive skin. We recommend that you hold the underneath of the oven door handle.

PREHEATING

Fanned oven

When cooking sensitive items such as soufflé and Yorkshire puddings or, when cooking bread, we recommend that the oven is preheated until the neon switches off for the first time. For any other types of cooking, a preheat may not be required.

Conventional oven

Preheating is always required

Manual Operation (fanned only)

The programmer must be set to manual operation before the main oven can be used. If A (Auto) is on the programmer display, return the oven to manual by pressing the up and down buttons simultaneously. Any programme which has been set is cancelled.

The cooling fan

The cooling fan may operate when the main oven is on and may continue to operate for a period after the oven has been switched off.

OVEN FURNITURE

Oven shelves

The oven shelf must be positioned with the upstand at the rear of the oven and facing upwards.

Position baking trays and roasting tins on the middle of the shelves, and leave five clear shelf positions between shelves, to allow for circulation of heat.

Baking tray and roasting tins

For best cooked results and even browning, the recommended size baking trays and roasting tins that should be used are as follows;

Baking tray 350mm x 250mm

This size of baking tray will hold up to 12 small cakes.

Roasting tin 370mm x 320mm

We recommend that you use good quality cookware. Poor quality trays and tins may warp when heated, leading to uneven baking results.

USING THE MAIN OVEN - ELECTRIC

Slow cooking (Setting or 100°C)

- Make sure that frozen foods are thoroughly thawed before cooking.
- Do not slow cook joints of meat or poultry weighing more than 2¼kg/4½lb.
- Preheat the oven to 170°C and cook for 30 minutes, then adjust the oven control to  or 100°C (slow cook setting) for the remainder of the cooking time.
- Slow cooking times will be about 3 times as long as conventional cooking times.
- Do not open the oven door unnecessarily during slow cooking, as this will result in heat loss at low temperatures.
- Always use dishes with tightly fitting lids. To rectify badly fitting lids, place foil over the dish underneath the lid.

Aluminium foil

Use foil only to cover food or cooking dishes, using foil to cover the shelves or oven base creates a fire hazard.

Cooking with a fanned oven

As this is a high efficiency oven, you may notice the emission of steam from the oven when the door is opened. Please take care when opening the door.

If you are used to cooking with a conventional oven you will find a number of differences to cooking with a fan oven which will require a different approach:

There are no zones of heat in a fan oven as the convection fan at the back of the oven ensures an even temperature throughout the oven.

This makes it ideal for batch baking - eg; when planning a party as all the items will be cooked within the same length of time.

Foods are cooked at a lower temperature than a conventional oven, so conventional recipe temperature may have to be reduced. Please refer to the conversion chart.

Preheating is generally not necessary as a fan oven warms up quickly.

There is no flavour transference in a fan oven, which means you can cook strong smelling foods such as fish at the same time as mild foods - eg; milk puddings.

When batch baking foods that will rise during cooking - eg; bread - always ensure that enough space has been left between the shelves to allow for the rise.

Notes:

When 2 or more shelves are being used, it may be necessary to increase the cooking time slightly.

Because the 2 oven shelves are wider than in many ovens, it is possible to cook 2 items per shelf - eg; 2 victoria sandwiches or 2 casseroles.

Although you need to keep in mind the points 'To help the air circulate freely' with careful choice of dishes and tins, it is possible to cook a complete meal, and perhaps something else for the freezer, in the oven at the same time.

When roasting meats, you will notice that fat splashing is reduced, which is due in part to the lower oven temperatures, and will help keep cleaning of the oven to a minimum.

Because a fan oven has an even temperature throughout the oven, there is no need to follow the shelf positions given in the baking guide.

USING THE MAIN OVEN - ELECTRIC

There is no need to interchange dishes onto different shelves part way through cooking, as with a conventional oven.

To help the air circulate freely

Position the shelves evenly within the oven and maintain a clearance from the oven roof and base.

If more than one cooking dish or baking tray is to be used on a shelf, leave a gap of at least 25mm between the items themselves and the oven interior.

Defrosting and cooling in the main oven

To defrost frozen foods, turn the main oven control to the defrost position, place the food in the centre of the oven and close the door.

To cool foods after cooking prior to refrigerating or freezing, turn the main oven control to the defrost position and open the door.

Defrosting times

Small or thin pieces of frozen fish or meat - eg; fish filets, prawns & mince will take approximately 1 - 2 hours.

Placing the food in a single layer will reduce the thawing time.

A medium sized casserole or stew will take approximately 3 - 4 hours.

A 1½kg/3lb oven ready chicken will take approximately 5 hours, remove the giblets as soon as possible.

Be safe

Do not defrost stuffed poultry using this method.

Do not defrost larger joints of meat and poultry over 2kg/4lb using this method.

Never place uncooked food for defrosting next to cooked food which is to be cooled, as this can lead to cross contamination.

Defrosting meat, poultry, and fish can be accelerated using this method but make sure they are completely thawed before cooking thoroughly. Place meat and poultry on a trivet in a meat tin.

MAIN OVEN BAKING GUIDE

Cooking times & temperatures

The temperature settings and times given in the baking guide are based on dishes made with block margarine. If soft tub margarine is used it may be necessary to reduce the temperature setting.

Allow enough space between shelves for food that will rise during cooking.

Do not place items on the oven base as this will prevent air circulating freely.



USING THE MAIN OVEN - ELECTRIC

Note: This is a high efficiency oven, therefore some adjustment will have to be made to conventional cooking temperatures. The table below shows conventional cooking temperatures, 'A' efficiency temperatures and gas marks. For optimum results,

conventional temperatures need to be converted to 'A' efficiency temperatures.

For example, an item which would normally cook at a conventional temperature of 180 °C, will now cook at the 'A' efficiency temperature of 160°C.

Conventional temperature (°C)	'A' Efficiency Oven (°C)	Gas Mark
100	100	1/4
110	110	1/4
130	120	1/2
140	130	1
150	140	2
160	150	3
180-190	160	4-5
200	170	6
220	180	7
230	190	8
250	200	9

Food Type	Temperature settings (°C)		Time Approx.	Shelf Position
	Conv	Fanned		
Cakes				
Small cakes	190	160	15 - 25	2 - 4
Victoria sandwich	180	160	20 - 30	3
Semi rich fruit cake	150	125	2.5HRS - 3HRS	2
Christmas cake	150	125	2.5HRS - 3HRS	2
Puddings				
Bread and butter pudding	170	150	45 - 1hr	3
Fruit crumble	200	175	40 - 1hr	3
Miscellaneous				
Yorkshire pudding:				
large	220	200	40 - 48	4 - 5
small	220	200	15 - 20	4 - 5
Shortcrust pastry	200	180	Depends on filling	4 - 5

USING THE MAIN OVEN - ELECTRIC

Traditional fruit cakes

It should be remembered that ovens can vary over time, therefore cooking times can vary, making it difficult to be precise when baking fruit cakes.

It is necessary therefore, to test the cake before removal from the oven. Use a fine warmed skewer inserted into the centre of the cake. If the skewer comes out clean, then the cake is cooked.

- Follow the temperatures suggested in the recipe and then adjust accordingly to the conversion table.
- Do not attempt to make Christmas cakes larger than the oven can cope with, you should allow at least 25mm (1") space between the oven walls and the tin.
- Always follow the temperatures recommended in the recipe.
- To protect a very rich fruit cake during cooking, tie 2 layers of brown paper around the tin.
- We recommend that the cake tin is not stood on layers of brown paper, as this can hinder effective circulation of air.
- Do not use soft tub margarine for rich fruit cakes, unless specified in the recipe.
- Always use the correct size and shape of tin for the recipe quantities.

Roast turkey

Roasting turkey involves cooking two different types of meat - the delicate light breast meat, which must not be allowed to dry out, and the darker leg meat, which takes longer to cook.

The turkey must be roasted long enough for the legs to cook, so frequent basting is necessary. The breast meat can be covered once browned.

- Always make sure that the turkey is completely thawed and that the giblets are removed before cooking.
- Turkey should be roasted at 160°C - 180°C (fanned) or 180°C - 200°C (conventional) for 20 minutes per 450g (1 lb), plus 20 minutes, unless packaging advises otherwise.
- The turkey can be open roasted, breast side down, for half of the cook time, and then turned over for the remainder of the cooking time.
- If the turkey is stuffed, add 5 minutes per 450g (1 lb) to the cooking time.
- If roasting turkey covered with foil, add 5 minutes per 450g (1 lb) to the cooking time.

To test if the turkey is cooked, push a fine skewer into the thickest part of the thigh. If the juices run clear, the turkey is cooked. If the juices are still pink, the turkey will need longer cooking.

USING THE MAIN OVEN - ELECTRIC

Roasting guide

The times given in the roasting guide are only approximate, because the size and age of the bird will influence cooking times as will the shape of a joint and the proportion of the bone.

Frozen meat should be thoroughly thawed before cooking. For large joints it is advisable to thaw over night.

Frozen poultry should be thoroughly thawed before cooking. The time required depends on the size of the bird - eg; a large turkey may take up to 48 hours to thaw.

Use of a trivet with a roasting tin will reduce fat splashing and will help to keep the oven interior clean. Alternatively, to help reduce fat splashing, potatoes or other vegetables can be roasted around the meat/poultry.

Notes:

- When cooking stuffed meat or poultry calculate the cooking time from the total weight of the meat plus the stuffing.
- For joints cooked in foil or covered roasters, and for lidded casseroles, add 5 minutes per 450g (1lb) to the calculated cooking time.
- Smaller joints weighing less than 1.25kg (2½lb) may require 5 minutes per 450g (1lb) extra cooking time.
- Position the oven shelf so that the meat or poultry is in the centre of the oven.
- It is recommended that the appliance is cleaned after open roasting.

Cook in main oven at: 160°C - 180°C (fanned) 180°C - 200°C (conventional)		Approximate Cooking Time (preheated oven)
Beef	Rare Medium Well done	20 minutes per 450g (1lb), plus 20 minutes 25 minutes per 450g (1lb), plus 25 minutes 30 minutes per 450g (1lb), plus 30 minutes
Lamb	Medium Well Done	25 minutes per 450g (1lb), plus 25 minutes 30 minutes per 450g (1lb), plus 30 minutes
Pork		35 minutes per 450g (1lb), plus 35 minutes
Poultry		20 minutes per 450g (1lb), plus 20 minutes

USING THE CLOCK/PROGRAMMER-ELEC(IF FITTED)

THE ALTERNATIVE PROGRAMMERS

There are two types of programmer covered in this section - push button & touch control. Both programmers have the same symbol variants & functions but may vary in their method of operation.

The push button programmer

Symbol	Symbol	What is it?
∨	-	<p>Down/minus</p> <p>Used to decrease cook / end time, remove minutes from the minute minder and adjust the time of day. Also for listening to and setting the alarm tone.</p>
∧	+	<p>Up/plus</p> <p>Used to increase cook / end time, add minutes to the minute minder and adjust the time of day.</p>
<p>FUNCTION</p> <p>or</p> 	<p>MODE</p>	<p>Function button</p> <p>Used to select the functions available on this timer.</p> <p>Press once for: Minute Minder. Press twice for: Cook time Press three times for: End time.</p> <p>How to use these functions is explained later on in this section.</p>

The 'function' button in the centre is used for setting the minute minder and setting up the automatic cooking. See below for details.

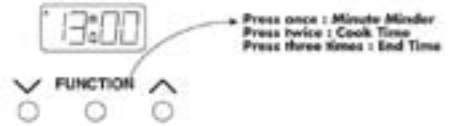

Symbols on the LED display.

This 'A' symbol appears when either a semi, or fully automatic program is selected. This symbol will flash while a program is being set.

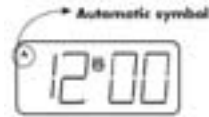

Once a program is set the symbol will light up, and remain lit until the alarm sounds, or the program is cancelled.

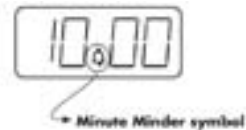

This bell symbol appears when the Minute Minder function has been selected.

While the Minute Minder is being set, the Bell symbol flashes. Once the length of time is set, the Bell symbol remains lit until the time runs down, or the function is cancelled.



This message and 'A' symbol appear when you are asked to set the length of time you require the oven to cook automatically for. Using the Up and Down buttons adjusts this accordingly.



This message and 'A' symbol appear when

USING THE CLOCK/PROGRAMMER-ELEC(IF FITTED)

you are asked to enter in an end time, or when you would like the oven to switch itself off.

To set the time of day

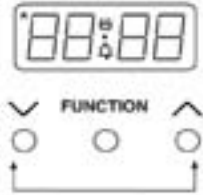

- Press the Up and Down buttons together for a few seconds, and release.
- The '•' in between the numbers on the LED Display will begin to flash.
- While the '•' is flashing it is possible to adjust the time using the Up and Down buttons. Once the time has been set, allow approximately 30 seconds before using any of the other timer functions. This ensures that the time will remain correct.

To select an alarm tone

There are three tones to choose from.

- Press and hold the down button to listen to the first tone.
- Release the down button and press it again to listen to the second tone etc.
- Releasing the down button after the tone has sounded will automatically select that tone.

Setting the minute minder

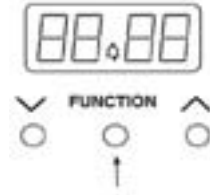

- To set the Minute Minder, press the Function button once. The bell symbol will appear and start flashing. The flashing only lasts for 5 seconds so the time must be set within this time frame.
- Use the Up and Down button to set the length of time required. Once this has been done, the Minute Minder is set.
- When the desired length of time has counted down the alarm will sound.
- To cancel the tone, press any of the buttons.
- To cancel the Minute Minder at any time, press the Up and Down buttons together.

USING THE CLOCK/PROGRAMMER-ELEC(IF FITTED)

Semi-automatic cooking

There are two types of semi automatic cooking available on this appliance.

The oven must be switched on, and in use to use either of these functions successfully.

The Duration method allows you to set the oven for a specific length of time. If a dish needed 2 hours to cook, then it would be possible for you to set the oven to turn off 2 hours later. This allows you to be sure that your food will be cooked for a set length of time and no longer.

The End Time method allows you to enter a specific time when you would like the oven to switch off. If you wish to leave the oven unattended, then it offers peace of mind that the oven will have turned itself off at the set time.

However, once the program is set then it cannot be adjusted. Extra time cannot be added, nor can the end time be extended.

To cancel the semi automatic programs, press both the Up and Down buttons together. This can be done at any time during the cooking process. Then if necessary, re program.

For the instructions on how to use both of these functions, please see the following page.

Fully automatic cooking

This function incorporates both a duration and an end time and is meant to be used when you wish to delay the start time.

We recommend that the first few times this function is used you are in the house, this will familiarise you with your oven and prevents food from being over cooked or under cooked.

Care must be taken when selecting foods for this function, it is not recommended for certain food items which may spoil, or are sensitive to being left.

It is also advisable to set the end time to be as close to your return as possible to prevent food being left standing.

USING THE CLOCK/PROGRAMMER-ELEC(IF FITTED)

SEMI-AUTOMATIC COOKING

The duration method

- Press the Function button twice,(1) which will skip past the Minute Minder.
- The LED display will flash the word 'dur', (2) and the 'A' will flash on the left hand side of the display.
- Use the Up and Down buttons to set the length of time you want to cook for.(3) This must be done within 5 seconds or the time of day will show again.

Once this is done the oven will automatically switch off once the time has elapsed, and the alarm will sound.

To switch off the alarm, press any button.
To view any remaining time press the function button twice.

The end time method

- Press the Function button three times, which will skip past the Minute Minder and the Duration programmer. (4)
- The LED display will flash the word 'End' and the 'A' will flash on the left hand side of the display. (5)
- Use the Up and Down buttons to select the time the oven is required to turn off. (6)

Once this is done the oven will turn itself off at the time you have selected.

To switch off the alarm, press any button.

1. The Duration method

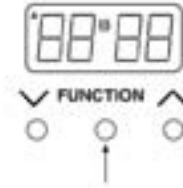

2.



3.

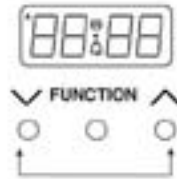

4. The End Time method

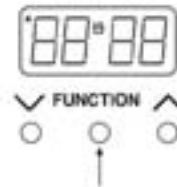

5.



6.

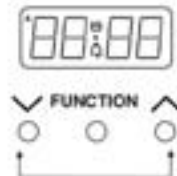

USING THE CLOCK/PROGRAMMER-ELEC(IF FITTED)

FULLY AUTOMATIC COOKING (EXAMPLE)

This programming method is best suited for when a delayed start time is required. Unlike the semi automatic methods this requires both the duration and the end time to be entered. The timer will work out the start time and begin cooking.

- Press the function button twice to select the length of time your food will need. (7)
- The 'A' on the left hand side will flash and the 'dur' message will flash up. (8)
- Using the Up and Down buttons set the time you require within 5 seconds of the 'dur' message. (9)
- Press the function button three times until the 'A' flashes again and the 'End' messages appears. (10) & (11)
- Using the Up and Down buttons, set the time you would like the oven to switch off. (12)
- Set the temperature of the oven and place the food inside.

While the automatic function is running, the 'A' will appear statically on the display, with the time.

Try to keep the end time as close to when you expect to return, this will prevent cooked food from being left standing in a warm oven.

The timer will calculate the appropriate start time.

To switch off the alarm, press any button.

7

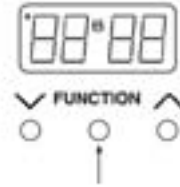

8



9

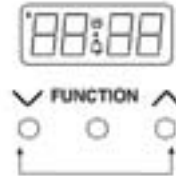

10

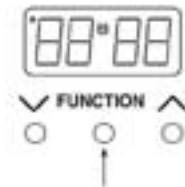

11



12

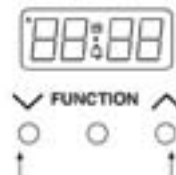

CLEANING

General

- It is important to clean the product regularly as a build up of fat can affect its performance or damage it and may invalidate your guarantee.
- Always switch off your appliance and allow it to cool down before you clean any part of it.
- Do not use undiluted bleaches, products containing chlorides, wire wool or abrasive cleaners on aluminium, stainless steel, or plastic/painted parts as they can damage the appliance. Nylon pads can also be unsuitable.
- Take extra care when cleaning over symbols on fascia panels. Excessive cleaning can lead to the symbols fading.
- If your product is fitted with stainless steel cladded stips. You may notice a small white residue on the outer edges, this can be removed with a non abrasive wipe.

Painted & Plastic parts

- Only use a clean cloth wrung out in hot soapy water.
- Do not use abrasive cleaners, wire or nylon cleaning pads on these parts.

Stainless steel & Aluminium surfaces

- Only use a clean cloth wrung out in hot soapy water, and dry with a soft cloth.
- Stubborn marks can be removed using a stainless steel cleaner. Supplies can be purchased from the Customer Care Centre.
- Sharp objects can mark the surface of stainless steel, but will become less noticeable with time.
- Wipe any spillage immediately, taking care to avoid burning your hands

- Some foods are corrosive eg; vinegar, fruit juices and especially salt - they can mark or damage the metal if they are left on the surface.
- Baby oil can be used to restore stainless steel finishes - but only use a few drops. Don't use cooking oils as they can contain salts, which will damage the metal.
- Do not use steam cleaners.

Enamel surfaces & parts

- Clean with warm, soapy water and a clean cloth.
- If larger splashes of fat do not readily disappear, you can use a mild cream cleaner to remove them. More stubborn marks can be removed using a soap filled pad.
- Rinse well and dry with a soft clean towel or cloth.
- Do not use steam cleaners.

Glass parts

WARNING:- Do not use harsh abrasive cleaners or sharp metal scrapers to clean the oven door glass since they can scratch the surface, which may result in shattering of the glass.

- Only use a clean cloth wrung out in hot soapy water, or a specialist glass cleaner.

Rinse away any excess cleaner and dry with a soft cloth.

Chrome plated parts

- Use a moist soap filled pad, or place in a dishwasher

CLEANING

REMOVING OVEN PARTS FOR CLEANING

Inner Door Glass (glass doors only)

- The inner door glass panel can be removed for cleaning but it must be replaced the right way up. If there is any writing on the glass, you must be able to read it clearly when the cavity doors are open.
- Always make sure that the glass is pushed fully into the Stop position.
- To remove the glass panel, open the door wide, hold the top and bottom edges and slide out.
- **Warning:** Do not operate the appliance without the glass panel correctly fitted.
- For your safety, glass door panels are made of toughened glass. This ensures that, in the unlikely event that a panel breaks, it does so into small fragments to minimise the risk of injury. Please take care when handling, using or cleaning all glass panels, as any damage to the surfaces or edges may result in the glass breaking without warning or apparent cause at a later date. Should any glass panel be damaged, we strongly recommend

that it is replaced immediately.

Shelf Runners

- Shelf runners can be removed to enable you to clean them thoroughly. Make sure they are cool to touch and then grasp the runners and slide out of their hanging holes.

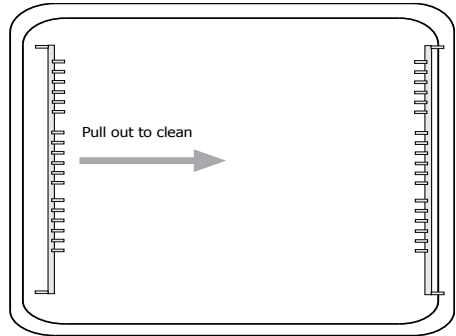

INSTALLATION

STEP 1 : PREPARE INSTALLATION

Do not lift the appliance by the door handle.

Whilst every care is taken to eliminate burrs and raw edges from this product, please take care when handling - we recommend the use of protective gloves during installation.

Please note that the weight of this appliance is approximately 31kg (unpacked). Take care when lifting it into the housing unit - always use an appropriate method of lifting.

Remove the fixing screws from the polythene bag on the top of the appliance, but leave the appliance in the base tray packaging until you are ready to install it.

If this appliance is to be installed near to a corner where the adjacent cabinets run at right angles forward of the appliance, there must be a gap of at least 90 mm between the appliance and the cabinets, to prevent overheating of the cabinets.

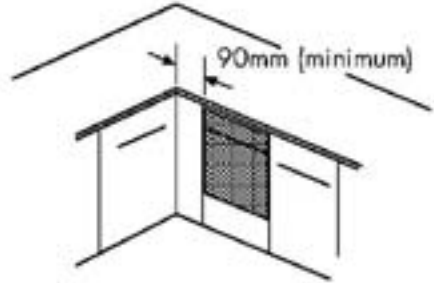

Housing dimensions

The appliance is designed to fit into a standard 600mm wide housing unit with minimum internal dimensions as shown.

590mm is to the underside of the worktop when the appliance is built under, or to the underside of the panel above, when the appliance is installed into a tall housing unit.

INSTALLATION - 70CM

Before you start

Please read the instructions carefully - planning your installation will save you time and effort.

Look at the different ways the appliance can be installed - as shown on the

following pages - and plan the installation to suit your situation.

Leave the appliance in the base tray packaging until you are ready to install it. When you remove the appliance from the base tray packaging, take care not to damage it.

Whilst every care is taken to eliminate burrs and raw edges from this product, please take care when handling - we recommend the use of protective gloves during installation.

Please note that the weight of this appliance is approximately 47kg

(unpacked). Take care when lifting it into the housing unit - always use an appropriate method of lifting.

This appliance must be installed only at low level - ie; under a worktop. The

controls have been designed for viewing at a low level, and it should therefore not be installed at high level.

Please note that all dimensions and sizes given are nominal, some variation is to be expected.

If this appliance is to be installed near to a corner where the adjacent cabinets run at right angles forward of the appliance, there must be a gap of at least 90mm between the appliance and the cabinets, to prevent overheating of the cabinets.

Important: Do not modify the outer panels of this appliance in any way.

Fixing screws - The fixing screws are in a polythene bag in the oven pack. Depending on the method of installation, some of the screws may not be needed.

Step 1: Prepare for installation

There are 3 methods of installing the appliance:

- Method 1: Into a space between two base units, ie; without a housing unit.
- Method 2: Into a housing unit, with an internal height of less than 710mm, which can be modified to obtain the required dimensions.
- Method 3: Into a housing unit, with an internal height of 710mm or more. If you have a non standard size of cabinet which leaves a gap above or below the appliance, you may be able to buy a trim kit (to fill in the gap) from the supplier of your cabinets.

Quantity	Colour	Description	For Fixing
6	Silver	No 8 x 12mm long Self tapping screw	Runners to appliance
12	Black	No 8 x 12mm long Chipboard screw	Runners and sidetrims to cabinet or housing
6	Black	No 8 x 25mm long Chipboard screw	Appliance to cabinet
2	Silver	No 8 x 12mm long Self tapping screw	Appliance to sidetrims

INSTALLATION - 70CM

METHOD 1: WITHOUT HOUSING UNIT(BETWEEN 2 BASE UNITS)

Before installing the appliance, check the internal dimensions as shown.

The space for the appliance must be clear of obstruction. You may have to cut into or remove any rear cross members to obtain the 550mm minimum depth.

The Fixing Kit

Should you need a replacement fixing kit please call the customer care helpline and order part number: 01 28287 00.

In the fixing kit you will find 2 side trims (687mm long) and 4 runners (420mm long). The fixing screws are in a polythene bag in the oven.

1. Take the 6 No 8 x 12mm (silver) self tapping screws from the polythene bag, and use them to fit one runner to each side of the appliance.

2. Make sure they are the right way up as shown.

3. Take one of the side trims, hold it against the side of the base unit, and mark off 687mm from the top edge of the base unit, to the top edge of the runner.

Note: This ensures a 5 - 8mm clearance from the underside of the worktop to the top of the appliance.

4. Measure 50mm from the front edge of the base units, to mark the front edge of the runners.

5. Take 6 of the No 8 x 12mm (Black) chipboard screws and screw the runners into opposition the right way up as shown.

6. Fit the side trims to be flush to the top and front edges of the base units, using the remaining 6 No 8 x 12mm (Black) chipboard screws.

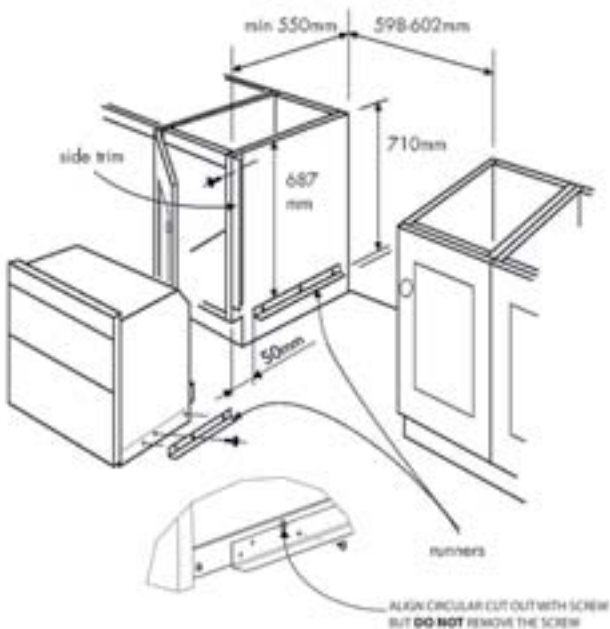

INSTALLATION - 70CM

METHOD 2: HOUSING UNIT WITH INTERNAL HEIGHT LESS THAN 710MM

Note: You will not need the 2 side trims (687mm long) or the appliance runners for this installation. You will need the 2 runners to fix to the adjacent cabinets.

Before you start;

Before removing the bottom shelf or modifying the housing unit, make sure that it will remain structurally sound, eg; by fixing to adjacent cabinets, floor or worktop.

You may have to cut into or remove any rear cross members to obtain the 550mm minimum depth.

To obtain the required 710mm height, you may have to lower or remove the bottom shelf - remove any cross rails and reposition brackets.

To fix the runners (if required)

1. Take the side trims, hold it against the side of the base unit, and use it to mark off the 687mm from the top edge of the side unit, to the top edge for the runner.

Note: This ensures a 5 - 8mm clearance from the underside of the worktop to the top of the appliance.

2. Measure 50mm from the front edges of the base units, to mark the front edge for the runners.

3. Take 6 of the No 8 x 12mm (Black) chipboard screws and screw the runners into position the right way up as shown.

4. If necessary, adjust the height of the plinth to just below the bottom edge of the runners.

If you require a replacement fixing kit please call the customer care helpline and order part number 01 28287 00.

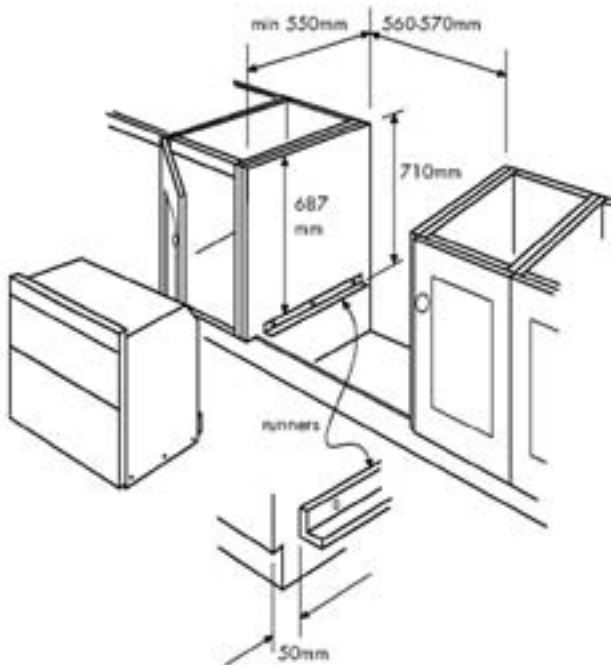

INSTALLATION - 70CM

Method 3: Housing unit with internal height 710mm or more

Note: You will not need the 4 runners and 2 trims that are packed with the oven for this installation.

fixing to adjacent cabinets, floor or worktop.

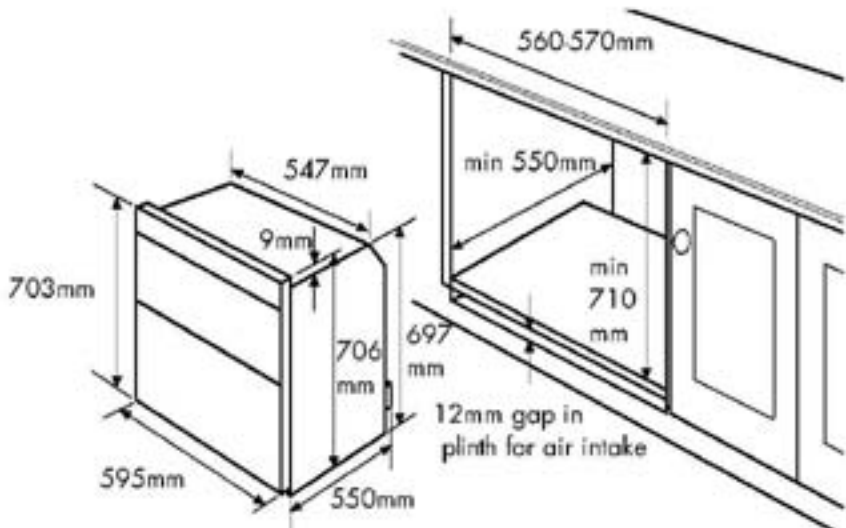

1. When installed in a typical 600mm deep built in housing unit, the false back should be removed from the housing unit to provide the necessary depth for installation.

2. When the false back is removed, it is normally the case that the support shelf for the appliance leaves a gap between the back edge and the wall of approximately 80mm.

3. If no gap occurs between the back edge of the shelf and the wall behind the unit, you must create a gap of at least 30mm by shortening the shelf.

Remove any fixings that may prevent entry of the oven into housing, or obstruct the gas inlet pipe. The cabinetry should be kept structurally sound by

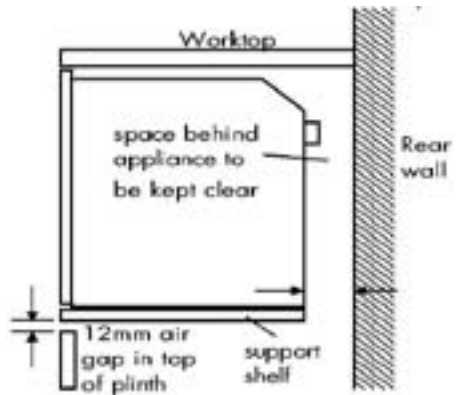

INSTALLATION - 90CM

STEP 1 : PREPARE INSTALLATION

Do not lift the appliance by the door handle.

Remove the fixing screws from the polythene bag on the top of the appliance, but leave the appliance in the base tray packaging until you are ready to install it. Whilst every care is taken to eliminate burrs and raw edges from this appliance, please take care when handling - we recommend the use of protective gloves during installation.

Please note that the weight of this appliance is approximately 48kg (unpacked). Take care when lifting it into the housing unit - always use an appropriate method of lifting.

Note: When removing the appliance from the base tray packaging care should be taken to ensure the appliance is not damaged.

Siting the appliance

If this appliance is to be installed near to a corner where the adjacent cabinets run at right angles forward of the appliance, there must be a gap of at least 90mm between the appliance and the cabinets, to prevent overheating of the cabinets. When installed in a typical 600mm deep built in housing unit, the false back should be removed from the housing unit, to provide the necessary depth for installation.

When the false back is removed, it is normally the case that the support shelf for the appliance leaves a gap between

the back edge of the support shelf and the rear wall of approximately 80mm.

If no gap occurs between the back edge of the shelf and the wall behind the unit, you must create a gap of at least 30mm by shortening the shelf and any other shelf below the appliance.

Cut 12mm from the top of any plinth that may be fitted (see diagram).

Important: Do not modify the outer panels of this appliance in any way.

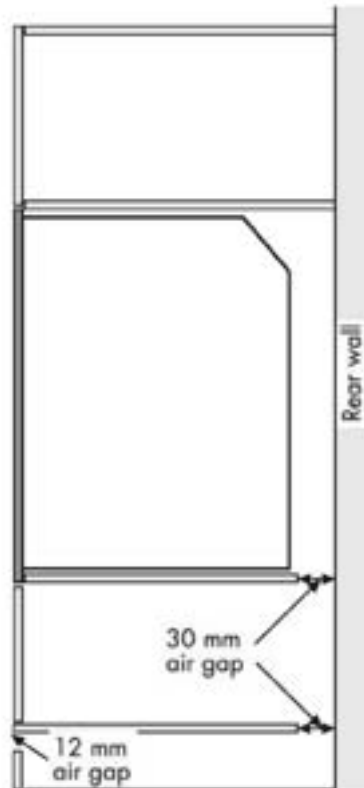

INSTALLATION - 90CM

Dimensions

The appliance is designed to fit into a standard 600mm wide housing unit, with minimum internal dimensions as shown.

Note: All sizes are nominal, some variation is to be expected.

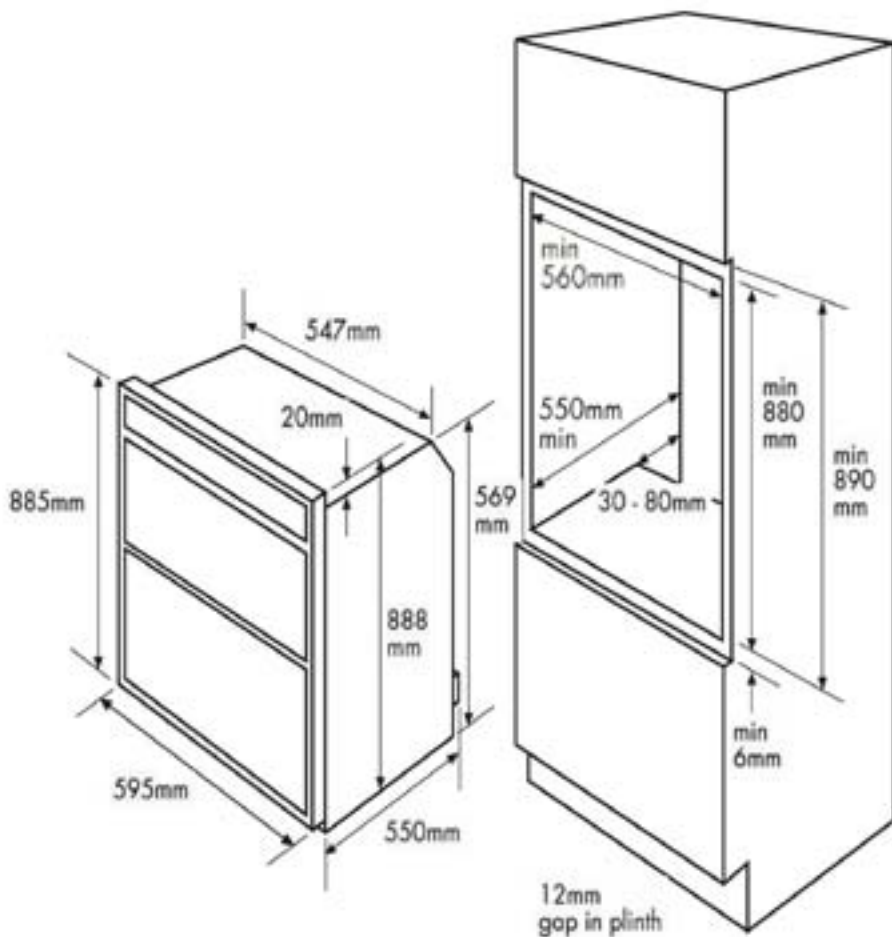

INSTALLATION

STEP 2 & 3 CONNECT TO THE ELECTRICITY SUPPLY

We recommend that the appliance is connected by a competent person who is a member of a "Competent Person Scheme" & who will comply with the I.E.E. & local regulations.

Important: Ensure that you route all mains electrical cables well clear of any adjacent heat source, such as an oven or grill.

Warning: This appliance must be earthed.

For 60cm BI appliance:

1. Where a fixed connection is used, a device allowing the appliance to be isolated on all poles from the mains supply with a contact opening width of at least 3mm must be provided.

Use a 13 amp fuse.

2. A type HO5 V V-F cable must be used as the mains lead. The cross section must be a minimum of 1.5mm².

3. The mains terminal block is located at the right hand rear of the top service panel.

4. Connect the cable to the terminal block & tighten the cable clamp.

5. Close the terminal box, ensuring the cover is engaged on the locking tabs.

For 70/90cm appliances:

1. The appliance must be installed using a double pole control unit of 32 ampere minimum capacity separation at all poles.

2. Access to the mains terminal is gained by opening the terminal block cover at the rear of the appliance (use a small flat bladed screwdriver).

3. Connection should be made with suitable twin & earth flexible cable, minimum 4mm² , which is suitable for use up to 25 amps.

4. First strip the wires, then push the cable through the cable clamp in the terminal block cover.

5. Connect the cable to the terminal block & tighten the cable clamp screw.

6. Close the terminal box, ensuring that the cover is engaged on the locking tabs.

INSTALLATION

STEP 4: SECURE APPLIANCE INTO HOUSING UNIT

60/70/90 fixing positions

Note : The unit housing the appliance must be appropriately fixed. Ensure that the appliance is centrally located. Take care not to damage the appliance or cabinetry.

70cm only

Method 1 : Care must be taken to ensure the appliance runners are sufficiently engaged over the top of the runners on the base units.

Method 2 : Insert appliance into the cabinet - ensure that it is engaged over the top of the side runners.

Method 3 : Insert appliance into cabinet

Note: For installation Method 1, you will need to drill through the fixing holes into the side trims with a 3.2mm diameter drill.

There are 4/6 black no 8 x 25mm long chipboard screws for securing appliance to cabinet. Insert appliance into cabinet and secure.

60cm ovens

- Open the oven door and screw the 4 fixing screws through the holes in the front frame.

70/90cm ovens

- Open the grill / top oven door, and screw 2 fixing screws through the top corner holes in the front frame.

- With the grill / top oven door still open, screw 2 fixing screws through the holes located under the grill compartment. Close the grill / top oven door.

- Open the main oven door and screw 2 fixing screws through the bottom corner holes in the front frame.



INSTALLATION

Anti-stain trim (if fitted)

The anti-stain trim is factory fitted to the edges of the appliance front frame.

This trim provides the cabinetry with extra protection from any escape of heat.

- When Installing the product, ensure the anti-stain trim is correctly located on the edges of the front frame, before positioning and securing the appliance to the cabinet.

- When securing the appliance, the fixing screws provided are driven through the anti-stain trim into the cabinet.

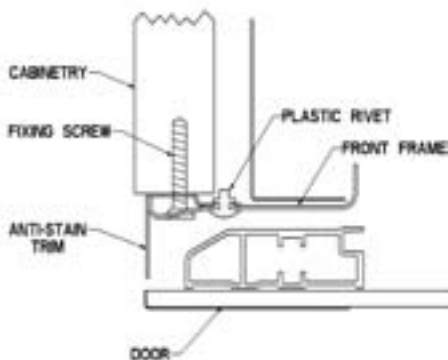

Note : When supplied the anti-stain trim may be loose and is only supported by plastic rivets. The anti-stain trim will be secured when the fixing screws are fully home into the cabinet. The plastic rivets should not be removed.

Edging strip (if fitted)

The edging strip is factory fitted to the edges of the appliance front frame. This strip provides the cabinetry with extra protection from any escape of heat.

When installing the product, ensure that the edging strip is correctly located on the outer edges of the front frame, before positioning and securing the appliance to the cabinet.

When securing the appliance, the fixing screws provided are driven through the edging strips into the cabinet - the seal will straighten up and sit flush to the cabinet when the screws are fully home.

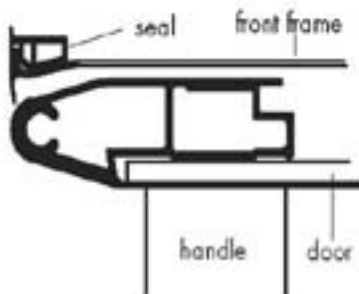

TECHNICAL DATA

ELECTRIC PRODUCTS

Electrical supply/load
220 - 240V ~ 50Hz

70cm / 90cm:
load = 5.5kW

Countries of destination

GB - Great Britain, IE - Ireland

Warning: This appliance must be earthed.
Databadge is located at the bottom of the front frame, behind the door.

CUSTOMER CARE

TROUBLESHOOTING GUIDE

What parts of the appliance can be washed in a dishwasher?

- Any enamelled parts such as the grill-pan can be cleaned in a dishwasher, as can oven shelves and shelf guides.

What parts must NOT be cleaned in a dishwasher?

- Parts such as burner skirts and caps, control knobs and any cast iron items must not be cleaned in a dishwasher, they should be cleaned with hot soapy water and a nylon brush once they are cool enough.

There's been a power failure and the product won't work.

- Switch off the electricity supply.
- When the power returns switch the electricity supply back on and re-set any programmer/clock to the correct time of day.

My oven is a single combined oven and grill - can I use both functions together?

- No. You can only use one or the other.

Why is there condensation on the doors?

- Condensation is caused by hot, moist air meeting a cooler surface (i.e. the oven door). You cannot always prevent it, but you can minimise it when it happens by doing the following:
- Pre-heat the oven at a high temperature before putting food in the oven, and cover the food you are cooking wherever possible.
- Whenever you can, cook wet foods at higher temperatures.
- Don't leave food in the oven to cool down.
- Automatic cooking will normally pro-

duce condensation when the oven is cooling down with food inside.

Should the cooling fan continue to run once the appliance has been switched off?

- Yes. This is to make sure that you can always touch the control knobs to make temperature adjustments, and turn your appliance off.

What is a Multifunction oven?

- A multifunction oven combines a variety of features, which are explained fully earlier in this book (if fitted), it allows you more flexibility when cooking.

The neon on my appliance keeps going out and coming back on again - is this right?

- Yes. In most cases the neon (if fitted) will cycle on and off to show that oven is maintaining your temperature choice.

Call Customer Care for a Service Engineer's visit if:

- You find that the oven becomes hotter at a particular temperature - the thermostat may need replacing.
- The cooling fan fails to work.

CUSTOMER CARE

AFTER-SALES SERVICE

Before calling the After-Sales Service:

1. See if you can solve the problem yourself with the help of the suggestions given in the "Troubleshooting guide".
2. Switch the appliance off and back on again it to see if the fault persist.

If after above checks the fault still occurs, get in touch with the nearest After-Sales Service.

- Always specify:
- A brief description of the fault;
- The type and exact model of the oven.
- The service number (number after the word Service on the rating plate), located on the hand edge of the oven cavity (visible when the oven door is open). The service number is also indicated on the guarantee booklet;
- Your full address;
- Your telephone number.



If any repairs are required, please contact an authorized After-Sales Service (to guarantee that original spare parts will be used and repairs carried out correctly).

CUSTOMER CARE

CHANGING LIGHT BULBS

This operation must be carried out by a qualified technician.

Warning: There is a risk of electric shock, so always make sure you have turned off and unplugged your appliance before starting. Always allow the product to cool down before you change a bulb.

Not all appliances have the same number and type of bulbs. Before replacing your bulb, open the oven door and see which type you have. Then use the table to help you change your bulb correctly.

Bulbs can be purchased from hardware stores (always take the old bulb with you).

Please remember that bulbs are not covered by your warranty.

The light bulb utilised in this product is not suitable for domestic illumination. (Regulation (EC) 244/2009).

No of Lamps	Bulb location	Oven Type	Instructions
2	Side	All	Remove the oven shelves. Grasp the lens cover on the light fitting and pull it away from the side of the oven. Unscrew the bulb and replace. Replace the lens cover
1	Rear	Fanned/Multifunction (Electric)	Remove the oven shelves. Remove the loose oven back by unscrewing the 4 securing screws (one at each corner) and remove. Unscrew the lens cover by turning anticlockwise. Remove the bulb and replace. Replace the lens cover and oven back.
1	Rear	Conventional/Fanned (Gas)	Remove the oven shelves. Unscrew the lens cover by turning anticlockwise. Remove the bulb and replace. Replace the lens cover.

Please keep this handbook for future reference, or for anyone else who may use the appliance.

Please keep this handbook for future reference, or for anyone else
who may use the appliance.

Please keep this handbook for future reference, or for anyone else
who may use the appliance.

Whirlpool is a registered trademark of Whirlpool USA.
Copyright Whirlpool Europe S.r.l All rights reserved